

Stage Curtains Finishes

At Azur Scenic, we make all our **stage curtains** to order.

Whatever you imagine, we can make it happen!

To help you make your choice, we've listed the most popular **stage curtains finishes**.

Of course, all the finishes suggested for the top of the curtain can also be applied to the sides and/or bottom. And vice versa!

Top finishes

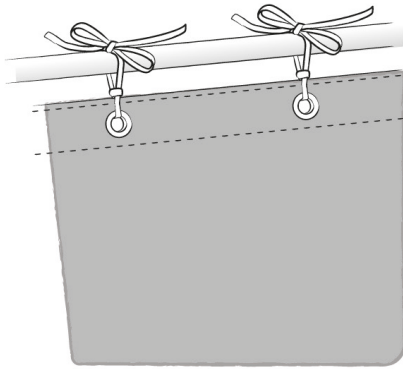

Tape, eyelets
and tie tapes

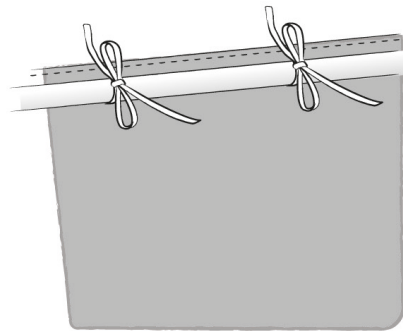

Tape with ties
sewn in a "U" shape

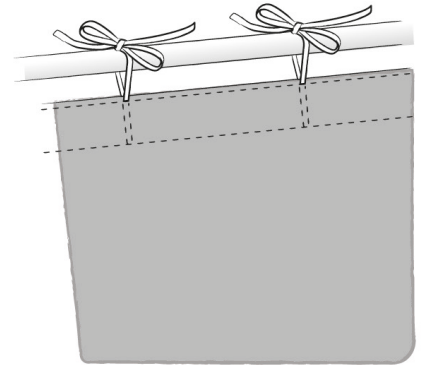

Tape with ties
sewn in a "V" shape

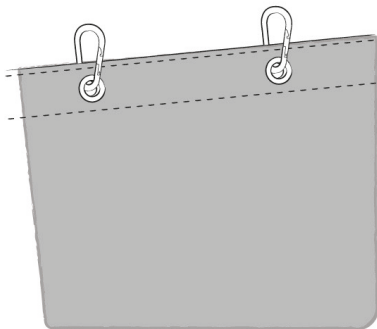

Tape, eyelets
and hooks

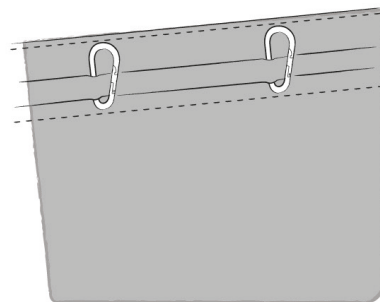

Tape with
sewn hooks

Side finishes

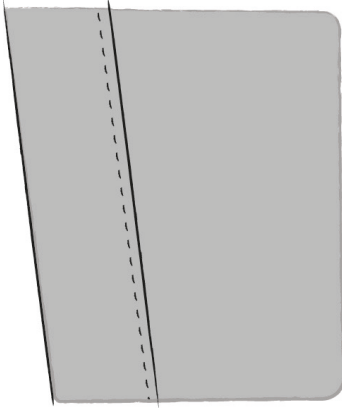

Hem

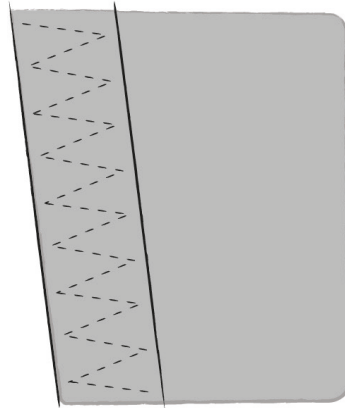

Overlock

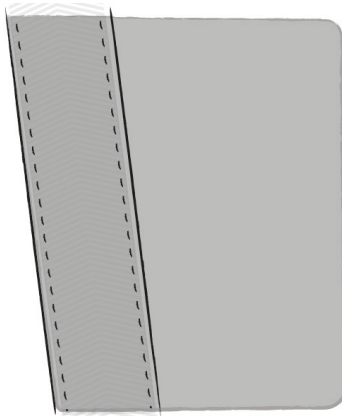

Reinforcement tape

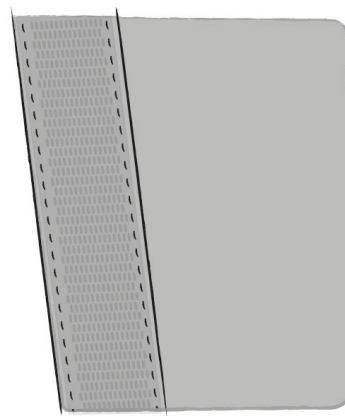

Hook & Loop tape

Bottom finishes

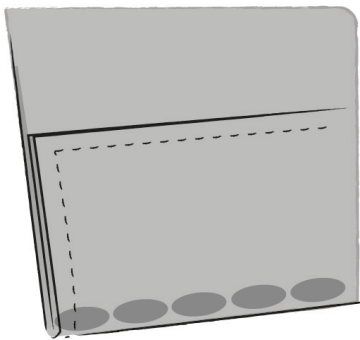

Chain pocket

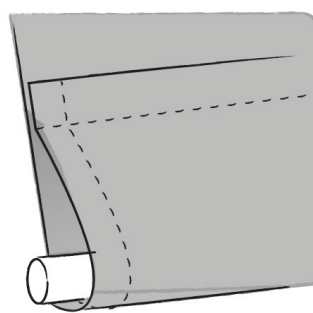

Pipe pocket

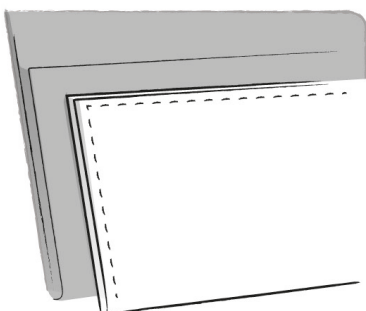

Chain pocket
with strap

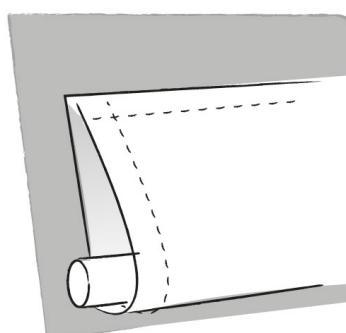

Pipe pocket
with strap

Fullness with reinforcement tape

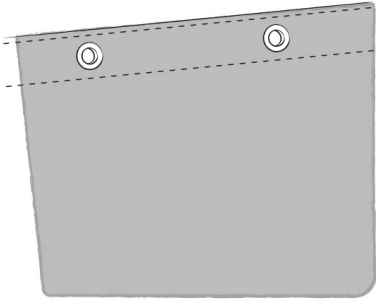

Flat

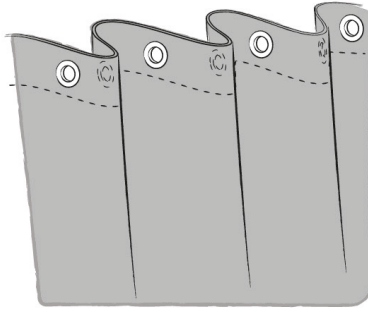

Free fullness

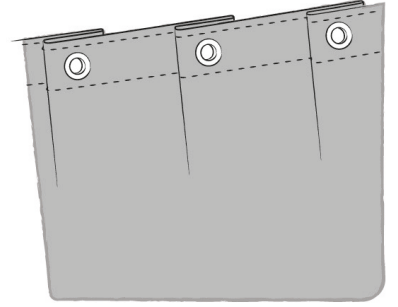

Sewn pleats
(Z shape)

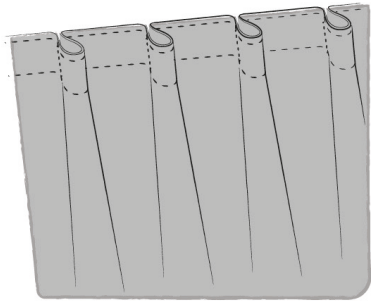

Sewn pleats
(Pinched shape)

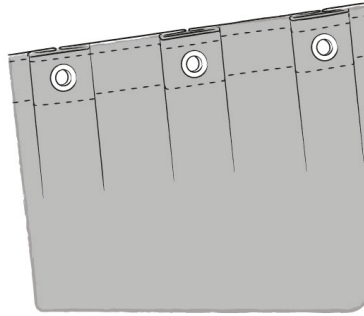

Sewn pleats
(Omega shape)

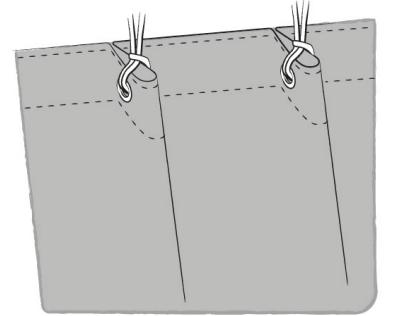

On-demand
pleating

Fullness with ruflette tape

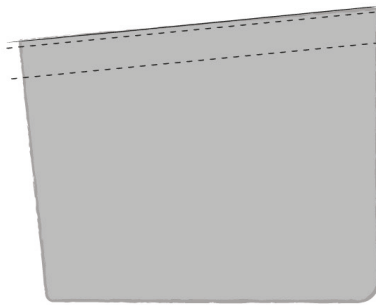

Flat

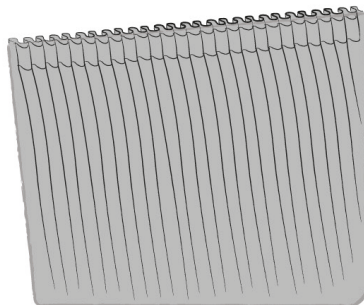

Gathered pleats

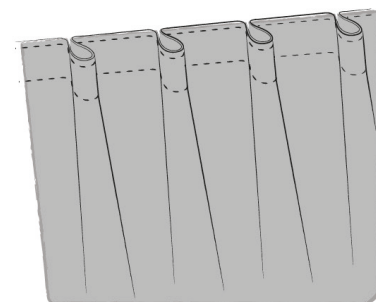

Single pleats

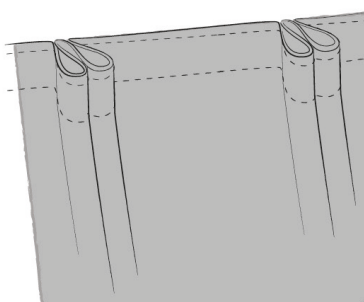

Double pleats

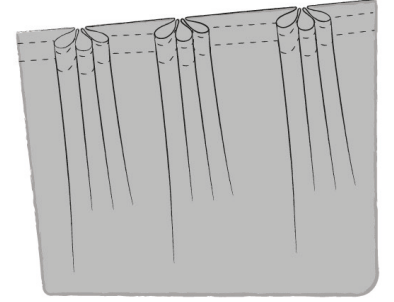

Triple pleats

Seams

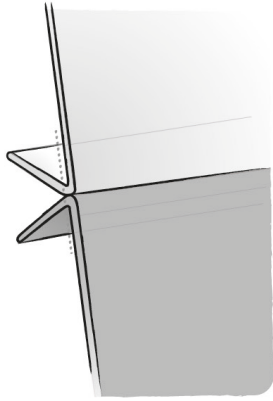

Simple seam

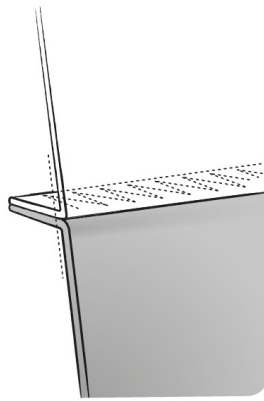

Overlock

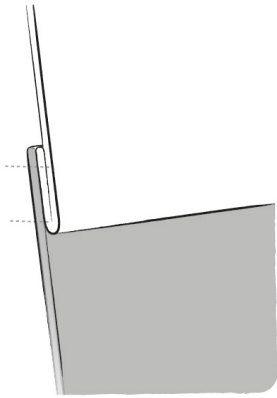

Single folded seam

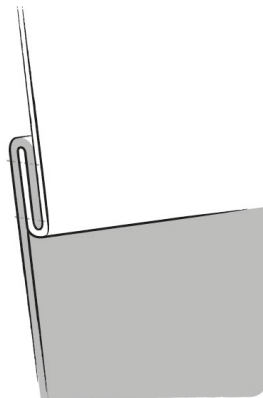

Double folded seam

YOUR EXPORT CONTACT

+33 6 23 21 50 28



export@azur-scenic.com